

Typ SPA - pro řemeny SPA, XPA, A/13, AX/13 / For belts SPA, XPA, A/13, AX/13

Dm	Dráž. Grooves	Označení - Obj.č. Part.No.	Pouzdro Bush	Max.díra Max.Bore	Typ Fig.	B [mm]	J [mm]	K [mm]	L [mm]	M [mm]	N [mm]	m [kg]
63	1	SPA063-01 TB	1108	28	9	20	31	18	40	-	68,5	0,6
	2	SPA063-02 TB	1108	28	9	35	31	33	55	-	68,5	0,8
67	1	SPA067-01 TB	1108	28	1	20	-	-	22	2	60	0,3
	2	SPA067-02 TB	1108	28	3	35	35	13	22	-	-	0,5
71	1	SPA071-01 TB	1108	28	1	20	-	-	22	2	60	0,3
	2	SPA071-02 TB	1108	28	3	35	39	13	22	-	-	0,5
	3	SPA071-03 TB	1108	28	3	50	39	28	22	-	-	0,7
75	1	SPA075-01 TB	1108	28	1	20	-	-	22	2	60	0,4
	2	SPA075-02 TB	1108	28	3	35	43	13	22	-	-	0,6
	3	SPA075-03 TB	1108	28	3	50	43	28	22	-	-	0,8
80	1	SPA080-01 TB	1210	32	1	20	-	-	25	5	80	0,5
	2	SPA080-02 TB	1210	32	3	35	50	10	25	-	-	0,6
	3	SPA080-03 TB	1210	32	3	50	50	25	25	-	-	0,9
85	1	SPA085-01 TB	1210	32	1	20	-	-	25	5	80	0,6
	2	SPA085-02 TB	1210	32	3	35	55	10	25	-	-	0,7
	3	SPA085-03 TB	1210	32	3	50	55	25	25	-	-	1,0
90	1	SPA090-01 TB	1210	32	1	20	-	-	25	5	80	0,7
	2	SPA090-02 TB	1610	42	3	35	60	10	25	-	-	0,7
	3	SPA090-03 TB	1610	42	3	50	60	23,5	26,5	-	-	1,0
	4	SPA090-04 TB	1610	42	3	65	60	40	25	-	-	1,2
	5	SPA090-05 TB	1610	42	3	80	65	55	25	-	-	1,5
95	1	SPA095-01 TB	1210	32	1	20	-	-	25	5	80	0,8
	2	SPA095-02 TB	1610	42	3	35	65	10	25	-	-	0,9
	3	SPA095-03 TB	1610	42	3	50	65	23,5	26,5	-	-	1,1
	4	SPA095-04 TB	1610	42	3	65	65	40	25	-	-	1,4
	5	SPA095-05 TB	1610	42	3	80	65	55	25	-	-	1,6
100	1	SPA100-01 TB	1610	42	1	20	-	-	25	5	92	0,8
	2	SPA100-02 TB	1610	42	3	35	65	10	25	-	-	0,9
	3	SPA100-03 TB	1610	42	2	50	65	-	25	25	-	1,2
	4	SPA100-04 TB	1610	42	2	65	65	-	25	40	-	1,7
	5	SPA100-05 TB	1610	42	3	80	65	55	25	-	-	1,9
	6	SPA100-06 TB	1610	42	4	95	65	30	25	40	-	2,3
106	1	SPA106-01 TB	1610	42	1	20	-	-	25	5	92	0,9
	2	SPA106-02 TB	1610	42	3	35	70	10	25	-	-	1,1
	3	SPA106-03 TB	1610	42	2	50	70	-	25	25	-	1,4
	4	SPA106-04 TB	1610	50	3	65	70	33	32	-	-	2,0
	5	SPA106-05 TB	1610	50	3	80	70	48	32	-	-	2,0
	6	SPA106-06 TB	2012	50	3	95	70	63	32	-	-	2,4
112	1	SPA112-01 TB	1610	42	1	20	-	-	25	5	92	1,0
	2	SPA112-02 TB	1610	42	3	35	77	10	25	-	-	1,2
	3	SPA112-03 TB	2012	50	3	50	77	18	32	-	-	1,3
	4	SPA112-04 TB	2012	50	3	65	77	33	32	-	-	1,9
	5	SPA112-05 TB	2012	50	3	80	77	48	32	-	-	2,1
	6	SPA112-06 TB	2012	50	3	95	77	63	32	-	-	2,4
118	1	SPA118-01 TB	1610	42	1	20	-	-	25	5	85	1,2
	2	SPA118-02 TB	1610	42	3	35	84	10	25	-	-	1,4
	3	SPA118-03 TB	2012	50	2	50	84	-	32	18	-	1,8
	4	SPA118-04 TB	2012	50	2	65	84	-	32	33	-	2,0
	5	SPA118-05 TB	2012	50	2	80	84	-	32	48	-	2,4
	6	SPA118-06 TB	2012	50	3	95	84	63	32	-	-	2,7

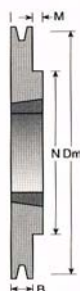

Figur 1

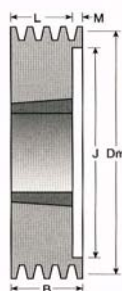

Figur 2

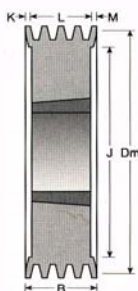

Figur 4

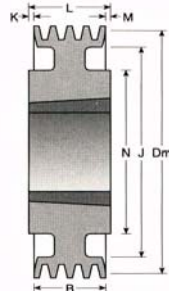

Figur 5

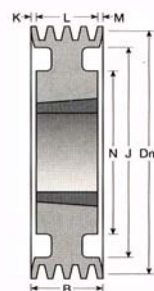

Figur 6

Typ SPA - pro řemeny SPA, XPA, A/13, AX/13 / For belts SPA, XPA, A/13, AX/13

Dm	Dráž. Grooves	Označení - Obj.č. Part.No.	Pouzdro Bush	Max.díra Max.Bore	Typ Fig.	B [mm]	J [mm]	K [mm]	L [mm]	M [mm]	N [mm]	m [kg]
125	1	SPA125-01 TB	1610	42	1	20	-	-	25	5	92	1,4
	2	SPA125-02 TB	1610	42	2	35	90	-	25	10	-	1,7
	3	SPA125-03 TB	2012	50	2	50	90	-	32	18	-	2,0
	4	SPA125-04 TB	2012	50	2	65	90	-	32	33	-	2,5
	5	SPA125-05 TB	2012	50	2	80	90	-	32	48	-	2,7
	6	SPA125-06 TB	2012	50	4	95	90	31,5	32	31,5	-	3,0
132	1	SPA132-01 TB	1610	42	1	20	-	-	26,5	6,5	92	1,6
	2	SPA132-02 TB	2012	50	2	35	98	-	32	3	-	1,8
	3	SPA132-03 TB	2012	50	2	50	98	-	32	18	-	2,3
	4	SPA132-04 TB	2517	65	2	65	98	-	45	20	-	2,6
	5	SPA132-05 TB	2517	65	2	80	98	-	45	35	-	2,9
	6	SPA132-06 TB	2517	65	4	95	98	25	45	25	-	3,3
140	1	SPA140-01 TB	1610	42	1	20	-	-	25	5	92	1,8
	2	SPA140-02 TB	2012	50	2	35	105	-	32	3	-	2,0
	3	SPA140-03 TB	2517	65	2	50	105	-	45	5	-	2,8
	4	SPA140-04 TB	2517	65	2	65	105	-	45	20	-	3,1
	5	SPA140-05 TB	2517	65	2	80	105	-	45	35	-	3,4
	6	SPA140-06 TB	2517	65	4	95	105	25	45	25	-	3,8
150	1	SPA150-01 TB	1610	42	1	20	-	-	25	5	92	1,4
	2	SPA150-02 TB	2012	50	2	35	115	-	32	3	-	2,4
	3	SPA150-03 TB	2517	65	2	50	115	-	45	5	-	3,5
	4	SPA150-04 TB	2517	65	2	65	115	-	45	20	-	3,8
	5	SPA150-05 TB	2517	65	2	80	115	-	45	35	-	4,2
	6	SPA150-06 TB	2517	65	4	95	115	25	45	25	-	4,8
160	1	SPA160-01 TB	1610	42	5	20	125	-	25	5	92	1,9
	2	SPA160-02 TB	2012	50	2	35	125	-	32	3	-	2,9
	3	SPA160-03 TB	2517	65	2	50	125	-	45	5	-	3,9
	4	SPA160-04 TB	2517	65	2	65	125	-	45	20	-	4,4
	5	SPA160-05 TB	2517	65	2	80	125	-	45	35	-	5,1
	6	SPA160-06 TB	2517	65	4	95	125	25	45	25	-	5,8
170	1	SPA170-01 TB	1610	42	5	20	135	-	25	5	92	2,0
	2	SPA170-02 TB	2012	50	2	35	135	-	32	3	-	3,1
	3	SPA170-03 TB	2517	65	2	50	135	-	45	5	-	4,6
	4	SPA170-04 TB	2517	65	2	65	135	-	45	20	-	5,5
	5	SPA170-05 TB	2517	65	2	80	135	-	45	29	-	5,9
	6	SPA170-06 TB	2517	65	4	95	135	22	45	22	-	6,5
180	1	SPA180-01 TB	1610	42	5	20	145	-	25	5	92	2,1
	2	SPA180-02 TB	2012	50	6	35	145	-	32	3	110	3,4
	3	SPA180-03 TB	2517	65	2	50	145	-	45	5	-	5,1
	4	SPA180-04 TB	2517	65	2	65	145	-	45	20	-	5,9
	5	SPA180-05 TB	3020	75	2	80	145	-	51	29	-	6,2
	6	SPA180-06 TB	3030	75	4	95	145	22	76	-	-	6,7
190	1	SPA190-01 TB	2012	50	5	20	155	-	25	5	92	2,3
	2	SPA190-02 TB	2517	65	6	35	155	-	32	3	110	3,8
	3	SPA190-03 TB	2517	65	2	50	155	-	45	5	-	5,4
	4	SPA190-04 TB	3020	75	2	65	155	-	51	20	-	6,8
	5	SPA190-05 TB	3020	75	2	80	155	-	51	29	-	7,4
	6	SPA190-06 TB	3030	75	4	95	155	22	76	-	-	8,1

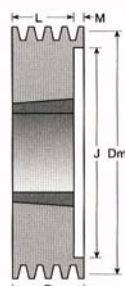

Figur 2

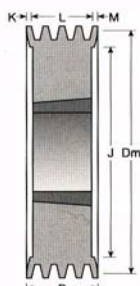

Figur 4

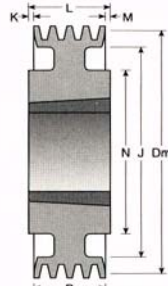

Figur 5

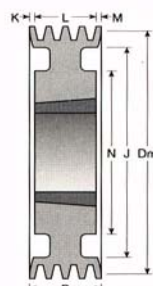

Figur 6

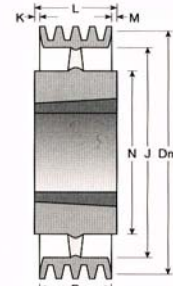

Figur 7

Typ SPA - pro řemeny SPA, XPA, A/13, AX/13 / For belts SPA, XPA, A/13, AX/13

Dm	Dráž. Grooves	Označení - Obj.č. Part.No.	Pouzdro Bush	Max.díra Max.Bore	Typ Fig.	B [mm]	J [mm]	K [mm]	L [mm]	M [mm]	N [mm]	m [kg]
200	1	SPA200-01 TB	2012	50	5	20	165	-	32	12	112	2,6
	2	SPA200-02 TB	2517	65	5	35	165	-	45	10	124	4,1
	3	SPA200-03 TB	2517	65	6	50	165	-	45	5	124	4,9
	4	SPA200-04 TB	3020	75	2	65	165	-	51	14	-	7,4
	5	SPA200-05 TB	3020	75	4	80	165	14,5	51	14,5	-	8,4
	6	SPA200-06 TB	3030	75	4	95	165	22	76	-	-	9,4
212	1	SPA212-01 TB	2012	50	5	20	177	-	32	12	112	2,7
	2	SPA212-02 TB	2517	65	5	35	177	-	45	10	124	4,3
	3	SPA212-03 TB	2517	65	6	50	177	-	45	5	124	5,2
	4	SPA212-04 TB	3020	75	2	65	177	-	51	14	-	7,3
	5	SPA212-05 TB	3020	75	2	80	177	-	51	20	-	8,2
	6	SPA212-06 TB	3030	75	4	95	177	22	76	-	-	9,2
224	1	SPA224-01 TB	2012	50	7	20	189	-	32	12	112	2,7
	2	SPA224-02 TB	2517	65	5	35	189	-	45	10	124	4,4
	3	SPA224-03 TB	2517	65	6	50	189	2,5	45	2,5	124	5,5
	4	SPA224-04 TB	3020	75	2	65	189	-	52,5	12,5	-	7,4
	5	SPA224-05 TB	3020	75	2	85	189	-	52,5	27,5	-	8,3
	6	SPA224-06 TB	3030	75	4	90	189	22	76	-	-	9,4
236	1	SPA236-01 TB	2012	50	7	20	201	-	32	12	112	2,8
	2	SPA236-02 TB	2517	65	5	35	201	-	45	10	124	4,6
	3	SPA236-03 TB	2517	65	6	50	201	2,5	45	2,5	124	5,7
	4	SPA236-04 TB	3020	75	2	65	201	-	52,5	12,5	-	7,8
	5	SPA236-05 TB	3020	75	2	80	201	-	52,5	27,5	-	8,7
	6	SPA236-06 TB	3030	75	4	95	201	22	76	-	-	9,7
250	1	SPA250-01 TB	2012	50	7	20	215	-	32	12	112	2,9
	2	SPA250-02 TB	2517	65	7	35	215	-	45	10	124	4,8
	3	SPA250-03 TB	2517	65	6	50	215	2,5	45	2,5	124	5,9
	4	SPA250-04 TB	3020	75	6	65	215	7	51	7	159	8,0
	5	SPA250-05 TB	3020	75	6	80	215	14,5	51	14,5	159	9,0
	6	SPA250-06 TB	3030	75	6	95	215	22	76	-	159	10,0
265	1	SPA265-01 TB IPL	2012	50	7	20	230	-	32	12	112	3,1
	2	SPA265-02 TB IPL	2517	65	7	35	230	-	45	10	124	5,1
	3	SPA265-03 TB IPL	2517	65	6	50	230	2,5	45	2,5	159	6,3
	4	SPA265-04 TB IPL	3020	75	6	65	230	7	51	7	159	8,4
	5	SPA265-05 TB IPL	3020	75	6	80	230	14,5	51	14,5	159	9,5
	6	SPA265-06 TB IPL	3020	75	6	95	230	22	51	22	159	10,5
280	1	SPA280-01 TB	2012	50	7	20	248	-	32	12	112	3,3
	2	SPA280-02 TB	2517	65	7	35	248	-	45	10	124	5,4
	3	SPA280-03 TB	2517	65	6	50	248	2,5	45	2,5	159	6,7
	4	SPA280-04 TB	3020	75	6	65	248	7	51	7	159	8,8
	5	SPA280-05 TB	3535	90	5	80	248	4,5	89	4,5	178	15,5
	6	SPA280-06 TB	3535	90	6	95	248	6	89	-	178	14,5
300	1	SPA300-01 TB	2012	50	7	20	265	-	32	12	112	3,5
	2	SPA300-02 TB	2517	65	7	35	265	-	45	10	124	5,8
	3	SPA300-03 TB	2517	65	5	50	265	0,5	51	0,5	159	7,4
	4	SPA300-04 TB	3020	75	6	65	265	7	51	7	159	9,3
	5	SPA300-05 TB	3535	90	5	80	265	4,5	89	4,5	178	16,2
	6	SPA300-06 TB	3535	90	6	95	265	6	89	-	178	15,5

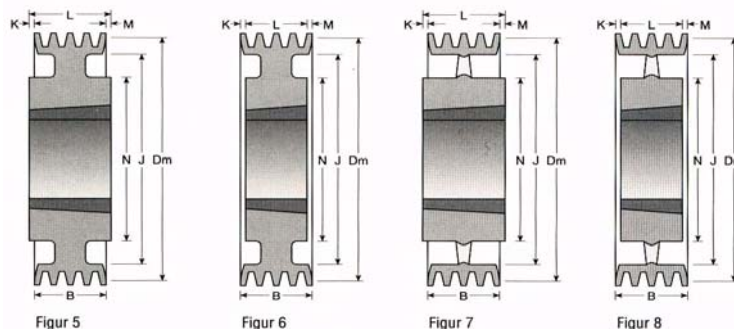

Typ SPA - pro řemeny SPA, XPA, A/13, AX/13 /For belts SPA, XPA, A/13, AX/13

Dm	Dráž. Grooves	Označení - Obj.č. Part.No.	Pouzdro Bush	Max.díra Max.Bore	Typ Fig.	B [mm]	J [mm]	K [mm]	L [mm]	M [mm]	N [mm]	m [kg]
315	1	SPA315-01 TB	2012	50	7	20	280	-	32	12	112	3,6
	2	SPA315-02 TB	2517	65	7	35	280	-	45	10	124	6,0
	3	SPA315-03 TB	3020	75	5	50	280	0,5	51	0,5	159	8,3
	4	SPA315-04 TB	3020	75	6	65	280	7	51	7	159	9,7
	5	SPA315-05 TB	3535	90	5	80	280	4,5	89	4,5	178	17,0
	6	SPA315-06 TB	3535	90	6	95	280	6	89	-	178	17,5
355	1	SPA355-01 TB	2012	50	7	20	320	-	32	12	112	4,2
	2	SPA355-02 TB	2517	65	7	35	320	-	45	10	124	6,7
	3	SPA355-03 TB	3020	75	7	50	320	0,5	51	0,5	159	9,2
	4	SPA355-04 TB	3020	75	8	65	320	7	51	7	159	11,0
	5	SPA355-05 TB	3535	90	7	80	320	4,5	89	4,5	178	18,6
	6	SPA355-06 TB	3535	90	8	95	320	6	89	-	178	19,0
400	1	SPA400-01 TB	2012	50	7	20	365	-	32	12	112	4,9
	2	SPA400-02 TB	2517	65	7	35	365	-	45	10	124	8,1
	3	SPA400-03 TB	3020	75	7	50	365	0,5	51	0,5	159	11,0
	4	SPA400-04 TB	3020	75	8	65	365	7	51	7	159	12,8
	5	SPA400-05 TB	3535	90	7	80	365	4,5	89	4,5	178	21,0
	6	SPA400-06 TB	3535	90	8	95	365	6	89	-	178	22,0
450	1	SPA450-01 TB	2012	50	7	20	418	-	32	12	112	7,0
	2	SPA450-02 TB	2517	65	7	35	418	-	45	10	124	10,3
	3	SPA450-03 TB	3020	75	7	50	418	0,5	51	0,5	159	14,1
	4	SPA450-04 TB	3020	75	8	65	418	7	51	7	159	15,5
	5	SPA450-05 TB	3535	90	7	80	418	4,5	89	4,5	178	24,3
	6	SPA450-06 TB	3535	90	8	95	418	6	89	-	178	25,2
500	1	SPA500-01 TB	2517	65	7	20	465	-	45	25	124	8,0
	2	SPA500-02 TB	2517	65	7	35	465	-	45	10	124	11,6
	3	SPA500-03 TB	3020	75	7	50	465	0,5	51	0,5	159	16,0
	4	SPA500-04 TB	3020	75	8	65	465	7	51	7	159	18,2
	5	SPA500-05 TB	3535	90	7	80	465	4,5	89	4,5	178	27,3
	6	SPA500-06 TB	3535	90	8	95	465	6	89	-	178	28,0
560	1	SPA560-01 TB	2517	65	7	20	525	-	45	25	124	11,6
	2	SPA560-02 TB	3020	75	7	35	525	-	51	16	159	15,5
	3	SPA560-03 TB	3020	75	7	50	525	0,5	51	0,5	159	17,8
	4	SPA560-04 TB	3535	90	7	65	525	12	89	12	178	26,7
	5	SPA560-05 TB	3535	90	7	80	525	4,5	89	4,5	178	30,4
	6	SPA560-06 TB	4040	100	8	95	525	15	102	15	178	31,5
630	1	SPA630-01 TB	2517	65	7	20	595	-	45	25	124	10,1
	2	SPA630-02 TB	3020	75	7	35	595	-	51	16	159	16,0
	3	SPA630-03 TB	3020	75	7	50	595	0,5	51	0,5	159	22,0
	4	SPA630-04 TB	3535	90	7	65	595	12	89	12	178	30,8
	5	SPA630-05 TB	3535	90	7	80	595	4,5	89	4,5	178	33,7
	6	SPA630-06 TB	4040	100	8	95	595	9,5	102	9,5	216	42,0
800	2	SPA800-02 TB	3535	90	7	35	766	27	89	27	178	29,3
	3	SPA800-03 TB	3535	90	7	50	766	19,5	89	19,5	178	34,5
	4	SPA800-04 TB	3535	90	7	65	766	12	89	12	178	39,0
	5	SPA800-05 TB	4040	100	7	80	766	11	102	11	216	54,0
	6	SPA800-06 TB	4030	100	8	95	766	9,5	76	9,5	216	55,0
	900	3	SPA900-03 TB	3535	90	7	50	866	19,5	89	19,5	178
4		SPA900-04 TB	3535	90	7	65	866	12	89	12	178	45,5
5		SPA900-05 TB	4040	100	7	80	866	11	102	11	216	58,7
6		SPA900-06 TB	4030	100	8	95	866	9,5	96	9,5	216	60,5